

# SERIE EURO 62



**TEMPLEX**  
TRITEMPLEX S.A.

## VENTANA / MAMPARA CORREDIZA



EURO 62  
Obra: Huarmey - Ancash



EURO 62  
Obra: La Molina -Lima



### Alternativas de diseño

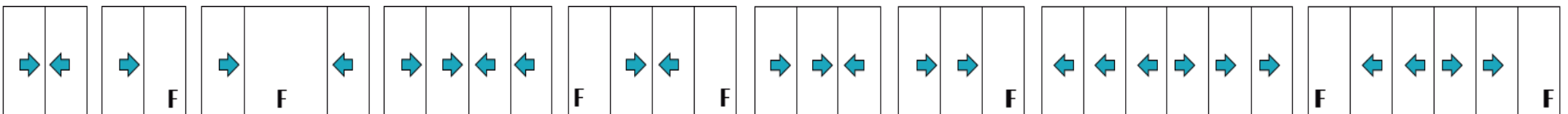

### Perfiles



Marco doble



Marco triple



Marco hoja  
monolítico



Marco hoja insulux



Traslape



Adaptador

### Espesor de Cristal

#### cristal monolítico

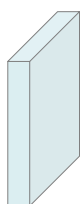

8 mm  
10 mm



#### cristal laminado

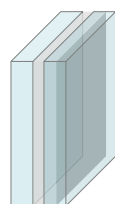

8,4 mm  
8,8 mm  
10,4 mm  
10,8 mm

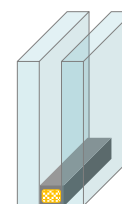

#### cristal insulado

21,5 mm  
23,5 mm  
24,3 mm  
24,7 mm  
25 mm





EURO 62  
Obra: Asia - Lima





### Accesorios

Cuenta con dos opciones de cierre

#### MANIJA MULTIPUNTO

Manija 

Cremona 

Kit cerraderos 

Calzo 



#### CIERRE EMBUTIDO

Cierre Embutido 

Cerradero 

Gancho 

Escuadra de ensamble 

Garrucha 

Viniles 

Felpa con barrera 

Guía 

Escuadras de alineamiento 

Calzo vidrio 

Cinta foam 





EURO 62  
Obra: Huarmey - Ancash



### Características

- Serie perimetral.
- Mínimo mantenimiento.
- Para todo tipo de edificación.
- Medida máx. recomendada 1400x2500.
- Ruedas que resisten hasta 40 y 100Kg por hoja.
- Deslizamiento silencioso y de fácil operación.
- Accesorios de cierre Embutido / Manija multipunto.
- Escuadras de alineamiento para una óptima unión de perfil marco hoja.
- Burletes de EPDM, con excelente resistencia al envejecimiento y a la luz ultravioleta.
- Felpa con barrera en el centro obtiene una mejora sustancial de la hermeticidad.
- Permite protección interna y/o externas al no generar obstáculo en su apertura.
- Acabados de perfil
 

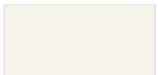
	Natural		Negro		Blanco
---	---------	---	-------	---	--------

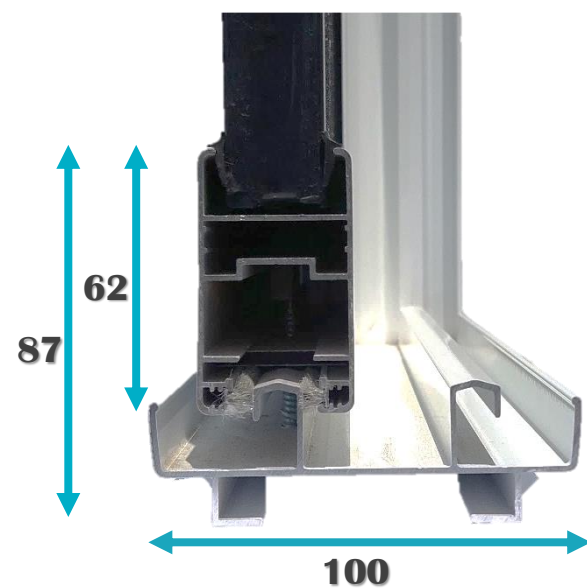



EURO 62

Obra: Huarney - Ancash





EURO 62

Obra: Huarney - Ancash





EURO 62  
Obra: La Molina - Lima





## Contacto :

 Avenida Los Rosales 555 , Santa Anita – 15009  
Lima - Perú

 +51 (1) 419-9000

 942 815 548

 [ventas@Templex.com.pe](mailto:ventas@Templex.com.pe)

 [www.templex.com.pe](http://www.templex.com.pe)

 [www.Facebook.com/tritemplex](http://www.Facebook.com/tritemplex)

 [www.instagram.com/tritemplex/](http://www.instagram.com/tritemplex/)

